

HEAT PUMP

HP0275

Heating*	Capacity Range	Btu/hr	101,941-288,226
	Power Input Range	kW	13-28
	Efficiency	COP	Up to 3.04
Heating**	Capacity Range	Btu/hr	188,981-66,345
	Power Input Range	kW	12.85-25.92
	Efficiency	COP	Up to 2.14
Cooling***	Capacity Range	Btu/hr	129,661-203,681
	Power Input Range	kW	8.7-23
	Efficiency	EER	2.5
	IPLV****	EER	17.18
Refrigerant	Type		R410a
	Amount (Qty)	lbs	20 (2)
	Pressure (low)	PSI	305
	Pressure (high)	PSI	638
Dimensions	Shipping (LxWxH)	in	89 x 50 x 89
	Unit (LxWxH)	in	86 x 45 x 84
	Weight	lbs	1615
Electrical	Volts/Ph/hz		460/3/60
	MCA	Amps	60
	MOPD	Amps	70
Hydronic	Pressure Drop (@75GPM)	PSI (ft/hd)	10 (23)
	Connection	In	4
	Min Flow	G.P.M.	44
	Max Flow	G.P.M.	75
	Max System Pressure	PSI	145
	Water Connection	In	4
	Sound @ 3 meters	dB(A)	67
	Operating temps	°F	-20-120

* Heating (DB)@ 47°F, Delivered Water 120°F per AHRI 550-590 (75 GPM) EWT 110°F

** Heating (DB)@ 17°F, Delivered Water 120°F per AHRI 550-590 (75 GPM) EWT 110°F

***Cooling (DB/WB)@ 95°F/86°F, Delivered Water 44°F per AHRI 550/590 (60GPM) EWT 54°F

****IPLV is the recognized measurement of efficiency for Integrated Part Load Values in accordance with AHRI 550/590.

Ambient temp = 95°F. Delivered Water = 44°F (44GPM)

Heat pump dimension and view

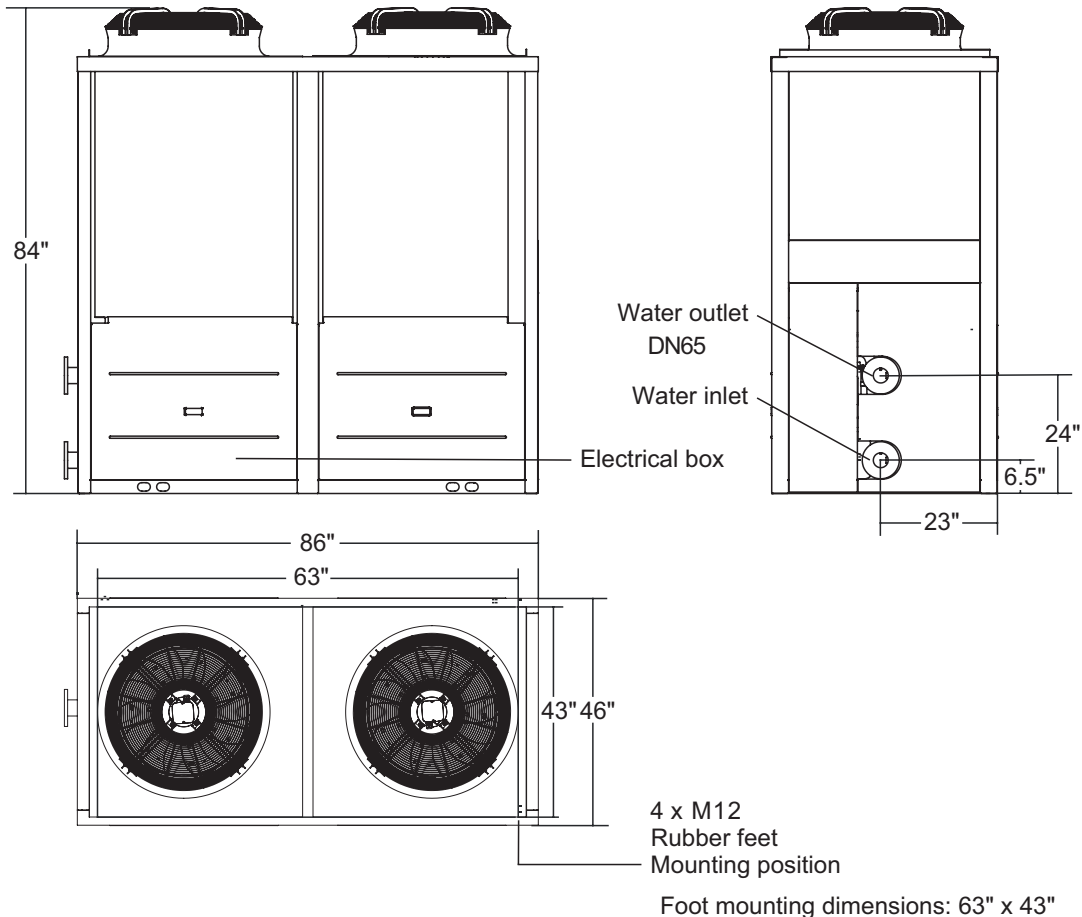

HEATING

Hz	Water T (°F)	Ambient (°F)	Capacity (btu/hr)	Power (kW)	COP
90	100	-20	145,242	21.13	2.01
		-4	173,960	21.31	2.39
		17	211,215	21.73	2.85
		47	322,135	23.28	4.05
	120	-20	129,954	25.21	1.51
		-4	155,648	25.42	1.79
		17	188,981	25.92	2.14
		47	288,226	27.77	3.04
	140	-20			
		-4	137,337	28.79	1.4
		17	166,748	29.36	1.66
		47	254,317	31.46	2.37
60	100	-20	98,888	21.13	1.67
		-4	118,441	21.31	1.98
		17	143,806	21.73	2.42
		47	213,626	23.28	3.65
	120	-20	88,479	25.21	1.25
		-4	105,973	25.42	1.48
		17	128,668	25.92	1.82
		47	191,139	27.77	2.74
	140	-20			
		-4	93,506	28.79	1.16
		17	113,531	29.36	1.41
		47	168,652	31.46	2.13
30	100	-20	47,899	10.57	1.33
		-4	57,370	10.75	1.56
		17	74,150	10.64	2.04
		47	113,934	10.59	3.15
	120	-20	42,857	12.61	1
		-4	51,331	12.82	1.56
		17	66,345	12.85	2.04
		47	101,941	12.99	3.15
	140	-20			
		-4	45,292	14.52	0.91
		17	58,539	14.38	1.19
		47	89,948	14.31	1.84

<p>REP FIRM _____</p> <p>SUBMITTED BY _____</p> <p>JOB NAME _____</p> <p>ARCHITECT _____</p> <p>ENGINEER _____</p> <p>CONTRACTOR _____</p> <p>DATE _____</p>	<div style="background-color: black; color: white; padding: 5px; font-weight: bold; font-size: 1.2em;">HEAT PUMP</div>  <p>A Division of Mestek, Inc. Westfield, MA 01085 (413) 564-5515</p>
---	---